



Aligning Safety, Security and Aesthetics in Architectural Openings

Altaf A. Afridi

Regional Marketing Director – MENA, DORMA

Email: altaf.afridi@dorma.com

Welcome



Course Description

Architectural openings are more about Life Safety than egress and fire rating only. The automatic and manual revolving, sliding or swing door can be hazardous for users unless properly designed as per relative standards and codes. More so when we deal with frameless glass assemblies and the user group includes disabled, elderly people and children. Also, adding security hardware may cause safety issues for doors.

While taking care of all these issues, the same doors are one of the main aesthetic elements in architectural and interior design and a balance is always needed to align all these aspects.

The presentation will focus on these points and will provide some case studies, how such challenges were resolved.



Presenter

Altaf Afridi, Regional Marketing Director (MENA) and head of the Project Management Team, based in United Arab Emirates, a Civil Engineer having 10 years of extensive experience in Architectural hardware and openings industry of his total 17 years of experience. Specialist of fire rated doors, first certified FDAI (Fire Door Assembly Inspector) outside US, certified Project Management Professional (PMP), LEED AP and Life Safety code (NFPA 101) specialist.

While working with architects Mr. Afridi has learnt NFPA 101 Life Safety Code, NFPA 80 Standard for fire doors from them while providing related solutions and thus gained a good data base of lessons learnt. He has been doing presentations on Life Safety code at architect offices in UAE, Saudi Arabia, Jordan, Lebanon and Qatar. He has been assisting architects providing solutions at the design stage for doors, doors hardware, movable walls, glass fittings and access control products.



Learning Objectives

- 1. Safety Risks related to different types of Architectural openings.*
- 2. Solutions in conformance to related Standards and Codes.*
- 3. Case Studies: Solution with Safety, Security and Aesthetics.*

- The purpose of this presentation is to convey technical knowledge to the conference participants.
- The presentation also contains slides with text that summarises the content of the presentation and the main learning objectives.
- These may be used to update CPD records for relevant organisations including the Chartered Institute of Building (CIOB).

Safety Design in Buildings

Aligning Safety, Security and Aesthetics
in Architectural Openings



Basic Architectural Openings

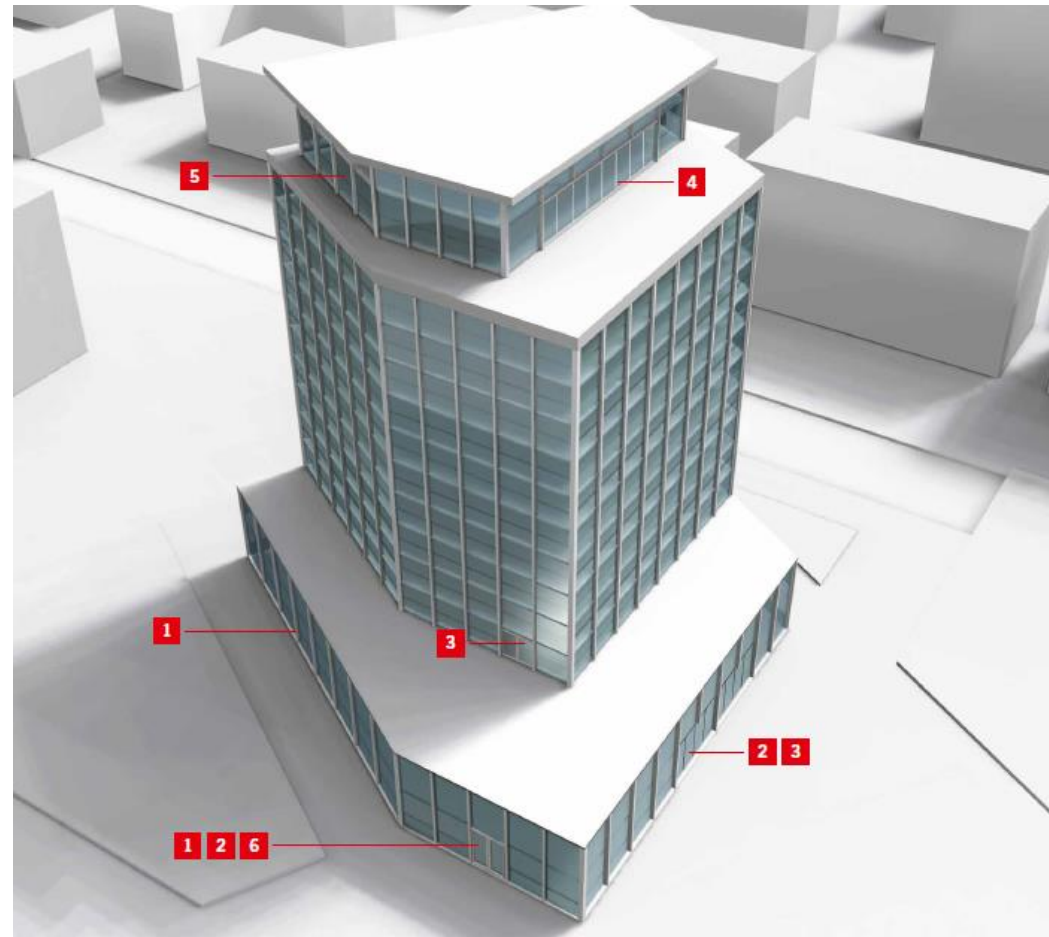



- A moving structure used to block off, and allow Entrance to or Exit from a space for Privacy, Convenience, security and safety reasons.
- Helps in controlling
 - Air Drafts,
 - Smoke and Fire
 - Noise Barrier.
 - Security
 - Component of Means of Egress





- A moving structure used to block off, and allow Entrance to or Exit from a space for Privacy, Convenience, security and safety reasons.
- Helps in controlling
 - Air Drafts,
 - **Smoke and Fire**
 - Noise Barrier.
 - **Security**
 - **Component of Means of Egress**

Safety Design in Buildings

Architectural openings and
Codes & Standards - **the missing link.**

Altaf A. Afridi, PMP, LEED AP, FDAI
at Gulf Hotel, Manama, Bahrain, Wednesday, Apr 17, 2013

Welcome

SESAM Safety Design in Buildings

altaf@dormagulf.com 00971-50-5507892

<http://www.safetydesigninbuildings.com/manama13/presentation/5.%20Altaf%20Afridi.pdf>

Safety Design in Buildings

Intersec Conference

DJITC Dubai Tuesday, January 20, 2015

Access Control & Egress Planning

Altaf A. Afridi, PMP, LEED AP, FDAI

altaf.afridi@dorma.com 00971-50-5507892

<http://safetydesigninbuildings.com/intersec/presentations/2015-01-20-Intersec-AIA-Altaf-Access%20Control%20and%20Egress%20Planning.pdf>



- Types of mechanism
 - Swing doors
 - Sliding doors
 - Revolving doors

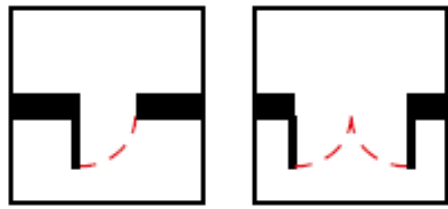



- Types of mechanism
 - Swing doors
 - Sliding doors
 - Revolving doors

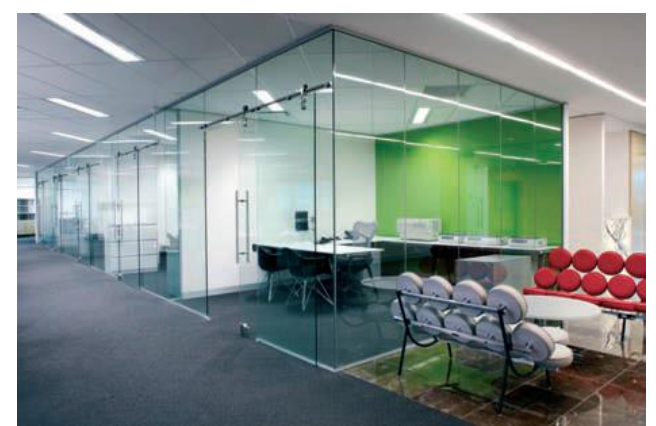
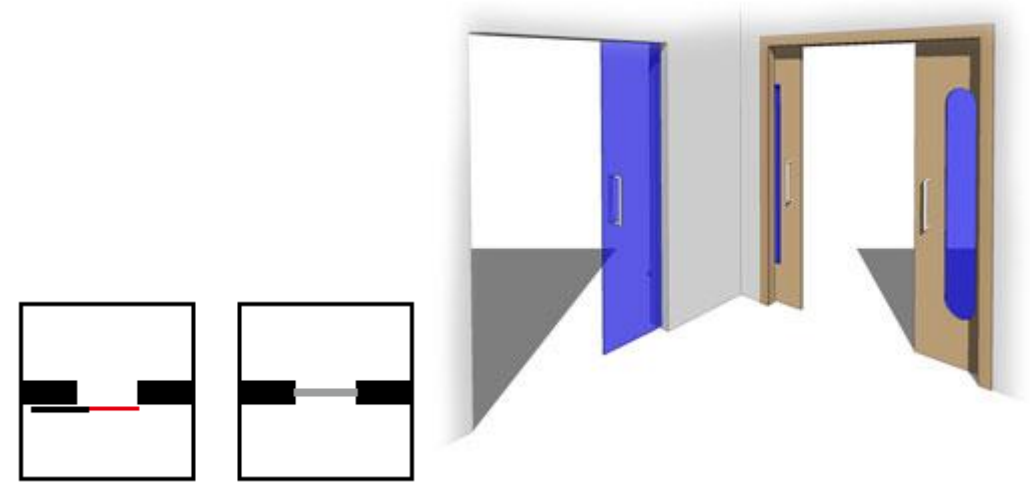



- Types of mechanism
 - Swing doors
 - Sliding doors
 - **Revolving doors**

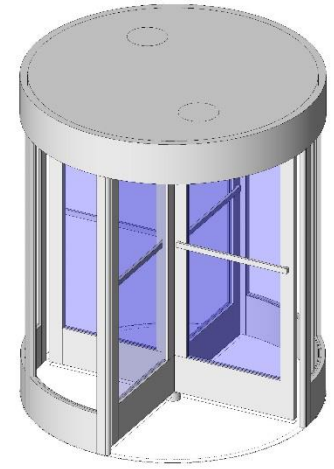
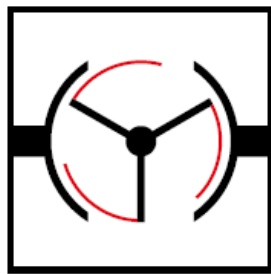



Safety Concerns of SWING DOORS

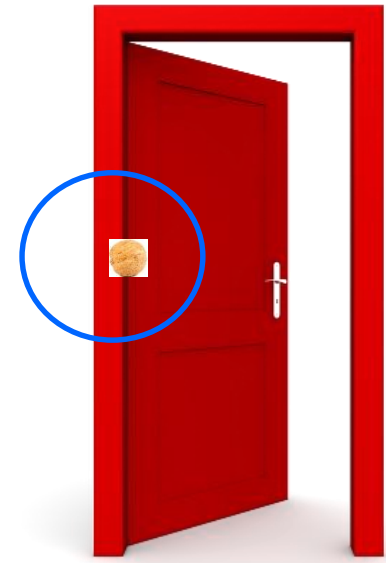
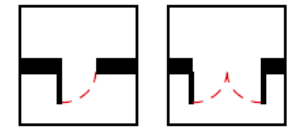

A closing door can exert up to **40 tons per square inch** of pressure between the hinges.



Safety Concerns of SWING DOORS

- Finger Pinching

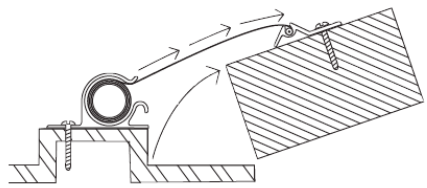
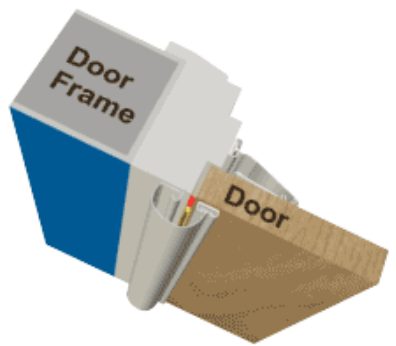
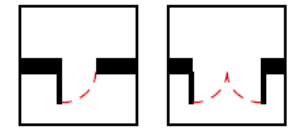

Safety Concerns of **SWING DOORS**

- Door Hardware:

Members in Society with Disabilities and old age people

- Shape

- No tight:

- **X Grasping,**
- **X Pinching,** or
- **X Twisting of the wrist.**

- Located **34"** to **48"** ((865mm to 1220mm)

- 5 seconds minimum closing time form 90 to 12 degree

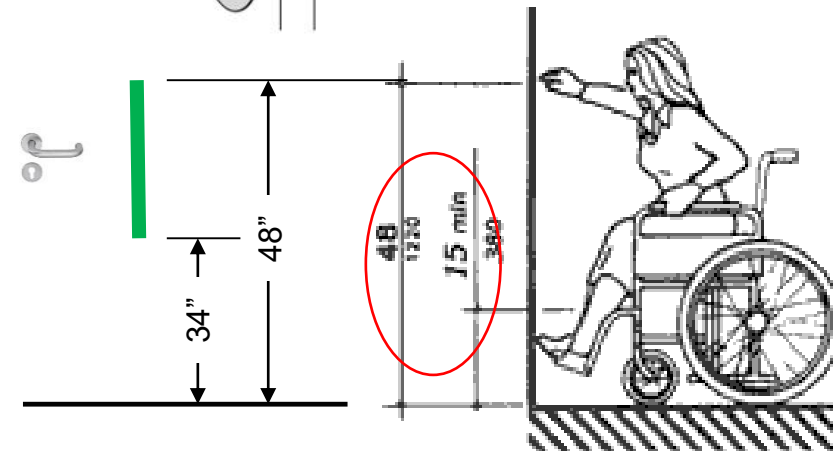
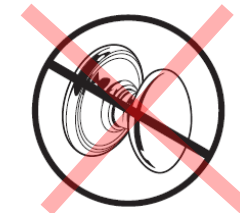
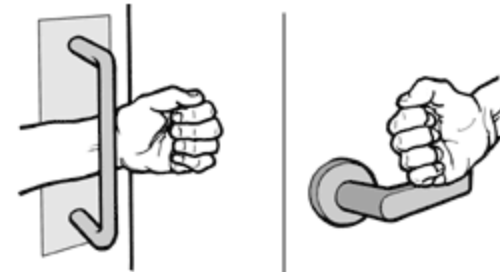

Source:



ADA-ANSIA A117.1



Safety Concerns of SWING DOORS

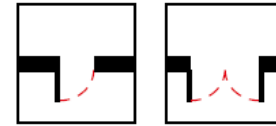

- Door Furniture



OGRO 8116



OGRO 8130



OGRO 8140



OGRO 8141



OGRO 8353



OGRO 8354



OGRO 8437



OGRO 8527



F EN 1634-1: Fire resistance tests for door and shutter assemblies

DIN 18273: Lever handle units for fire doors and smoke control doors



E EN 179: Emergency exit devices operated by a lever handle or push pad

⊠ Particularly suitable for hospitals, senior homes and care institutions, as well as other applications requiring barrier-free accessibility (simple elbow actuation)

♠ Braille available as option for material indicated

■ Stainless steel

■ Aluminium

Safety Concerns of SWING DOORS

- Door Furniture

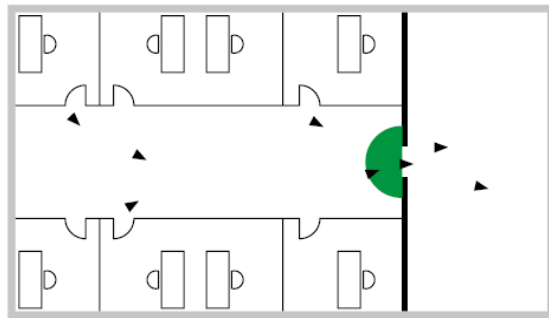
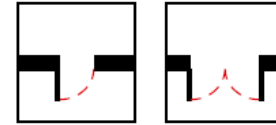

EN 179 – Emergency exit devices operated by a lever handle

Relevant dimensions to EN 179:2008

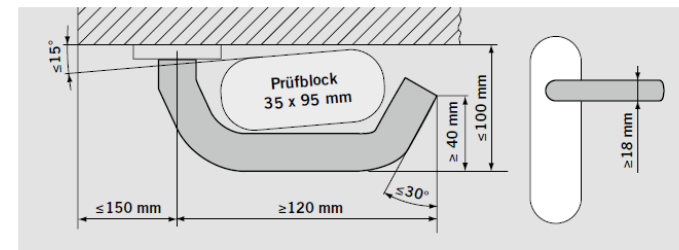

The gauge block, angle $\leq 15^\circ$ with respect to the door surface, must pass between the lever handle and the door.

The certified lever handles are marked with an **E**.

F EN 1634-1: Fire resistance tests for door and shutter assemblies

DIN 18273: Lever handle units for fire doors and smoke control doors



E EN 179: Emergency exit devices operated by a lever handle or push pad

Particularly suitable for hospitals, senior homes and care institutions, as well as other applications requiring barrier-free accessibility (simple elbow actuation)

Braille available as option for material indicated

Stainless steel

Aluminium

Safety Concerns of SWING DOORS

- Door Furniture

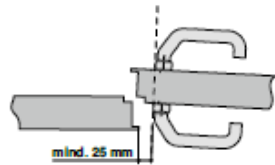
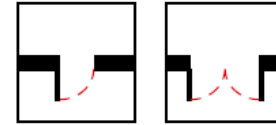

Please note: A minimum clearance of 25 mm must be maintained between the lever handle and the frame stop.

<p>OGRO 8116V F E ■ ■ </p>	<p>OGRO 8140 F ■</p>	<p>OGRO 8140A F ■</p>	<p>OGRO 8141 F ■</p>
<p>OGRO 8141A F ■</p>	<p>OGRO 8155V F ■ ■ </p>	<p>OGRO 8350A F E ■ ■ </p>	<p>OGRO 8350V F E ■ ■ </p>
<p>OGRO 8527 F E ■ ■ </p>	<p>OGRO 8527A F E ■ ■ </p>	<p>OGRO by Sieger 8830 F E ■ ■</p>	<p>OGRO by Sieger 8830A F E ■</p>

F EN 1634-1: Fire resistance tests for door and shutter assemblies

DIN 18273: Lever handle units for fire doors and smoke control doors



E EN 179: Emergency exit devices operated by a lever handle or push pad

Particularly suitable for hospitals, senior homes and care institutions, as well as other applications requiring barrier-free accessibility (simple elbow actuation)

Braille available as option for material indicated

■ Stainless steel

■ Aluminium



Safety Concerns of SWING DOORS

- Locking Fire Escape door

Safety codes requires Means of Egress to Unobstructed.

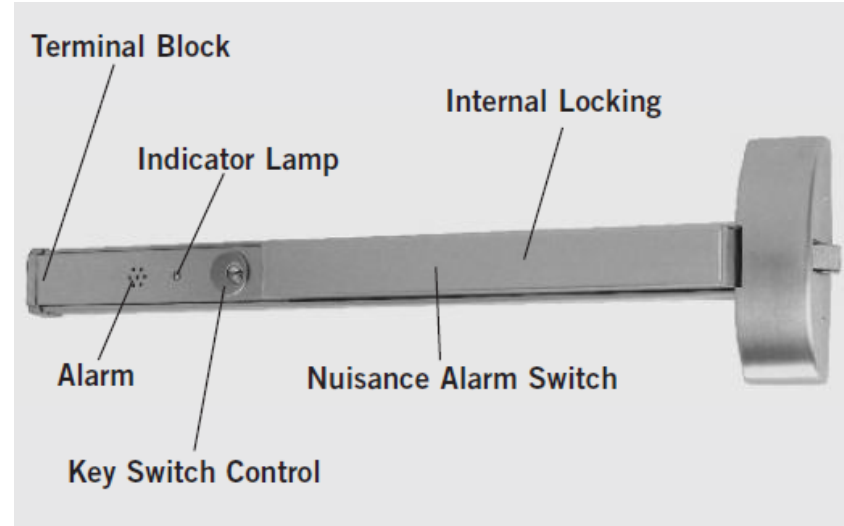
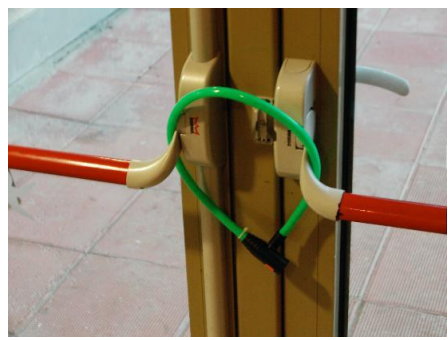
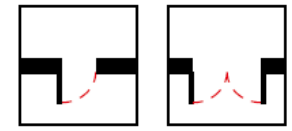

DORMA DE9000 Delayed Egress Panic Bar

PUSH UNTIL ALARM SOUNDS. DOOR CAN BE OPENED IN 15 SECONDS



Safety Concerns of SWING and SLIDING DOORS

- Floor Level.
 - The elevation difference of the floor surfaces not to more than 1/2". (13mm) on both sides of the door openings for a door leaf width.
 - Thresholds at door openings shall not exceed 1/2". (13mm) in height. (NFPA & ADA)
 - Raised thresholds and floor level changes in excess of 1/4 in. (6.3 mm) at door openings shall be beveled with a slope 1 in 2. (NFPA & ADA)

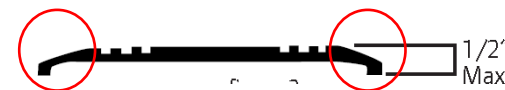
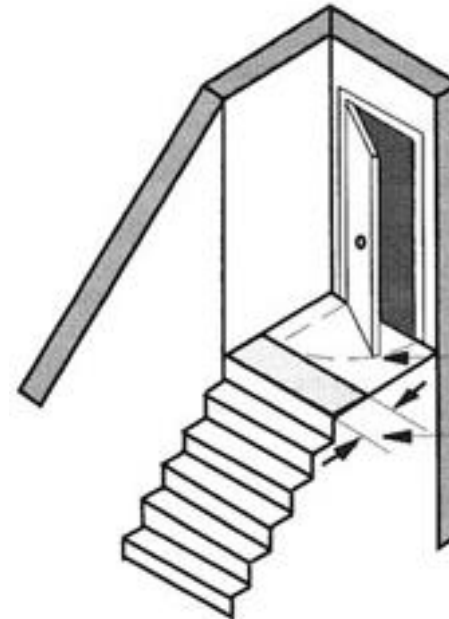

Source:

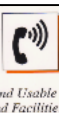

Accessible and Usable
Buildings and Facilities

ADA

NFPA 101 Life Safety Code
ADA-ANSIA A117.1

Safety Concerns of SWING and SLIDING DOORS

- Door Leaf Operating Forces.

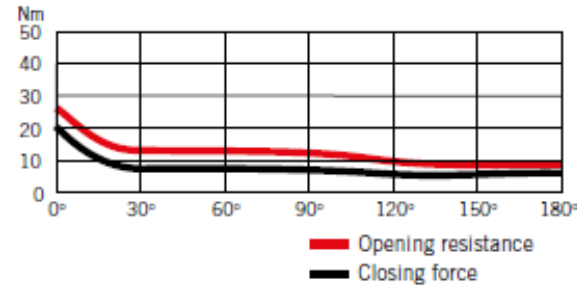

NFPA 101 Life Safety Code:

The forces required to fully open door leaf manually in a means of egress shall Maximum:

1. **30 lbf (133 N)** to set the leaf in motion, and
2. **15 lbf (67 N)** to open the leaf to the minimum required width.

ADA - ANSI/ICC A117.1 Accessible and Usable Buildings and

The force for pushing or pulling open a door or gate other than fire doors shall be **5 lbf (22.2 N)**
Maximum

NFPA 80 Standard for Fire openings

To ensure door is in closed position during fire, requires Minimum Door Closer of **Size-3**.

Source:



NFPA 101
NFPA 80
ADA-ANSIA A117.1

Safety Concerns of SWING DOORS

- Door Leaf Operating Forces.

Door Closer Technology



Rack and Pinion Type

Standard slide channel door closer
Without EASY OPEN: asymmetric gearing



Linear decrease in opening resistance

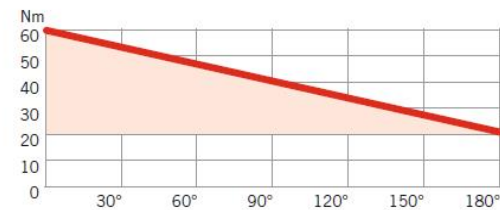

CAM Action Technology

DORMA slide channel door closer
with EASY OPEN technology featuring the heart-shaped cam



Rapidly decreasing opening resistance

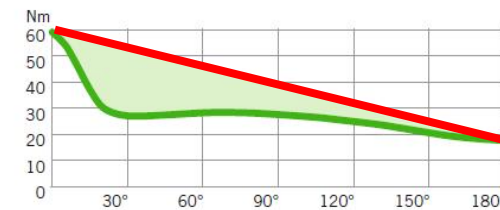

Reduction in opening effort thanks to EASY OPEN cam-action technology





- Types of mechanism
 - Swing doors
 - Sliding doors
 - Revolving doors

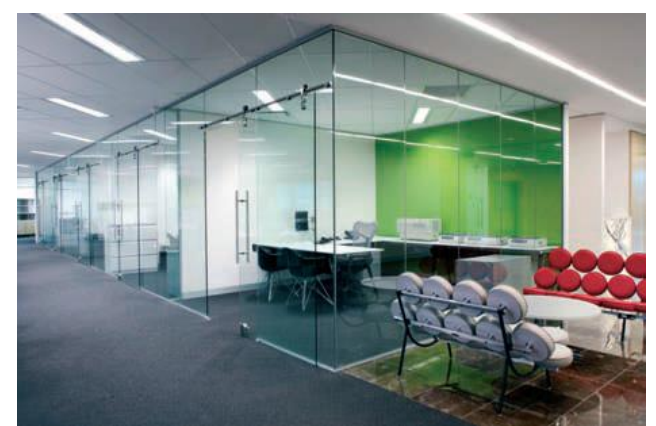
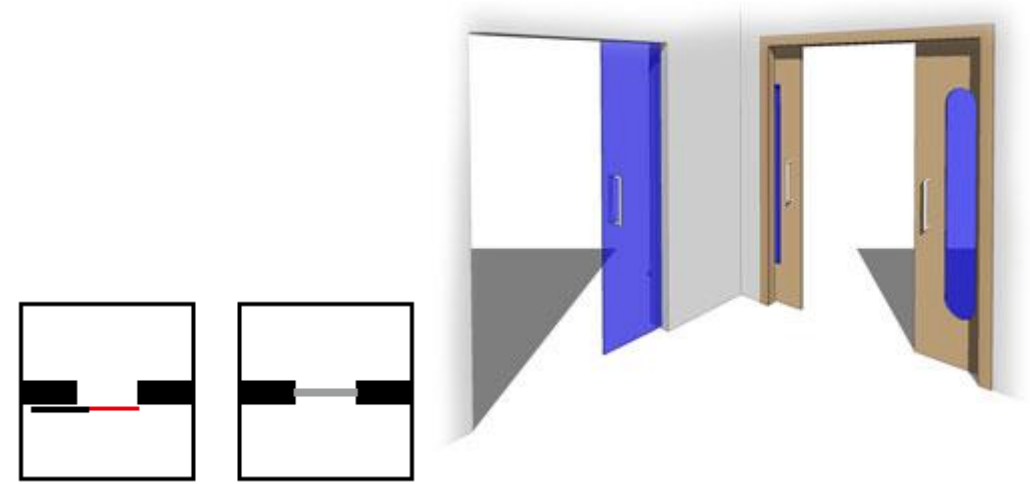



Safety Concerns of **SLIDING DOORS**

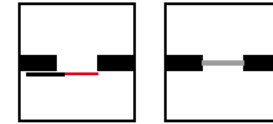

- Power operated Automatic Sliding door with **Break out feature.**

- **NFPA 101** The break out feature should require max force of 50 lbf (**222N**) force to swing open the door, a door need to have a sign 'IN EMERGENCY, PUSH TO OPEN'.
- **DIN 18650, BS 7036 and EN16005** German, BS and EN standards for Automatic Sliding doors, require breakout force of **220N**.
- **AS 5007**, Australian standard for Automatic doors requirement is **110N** (half of others)

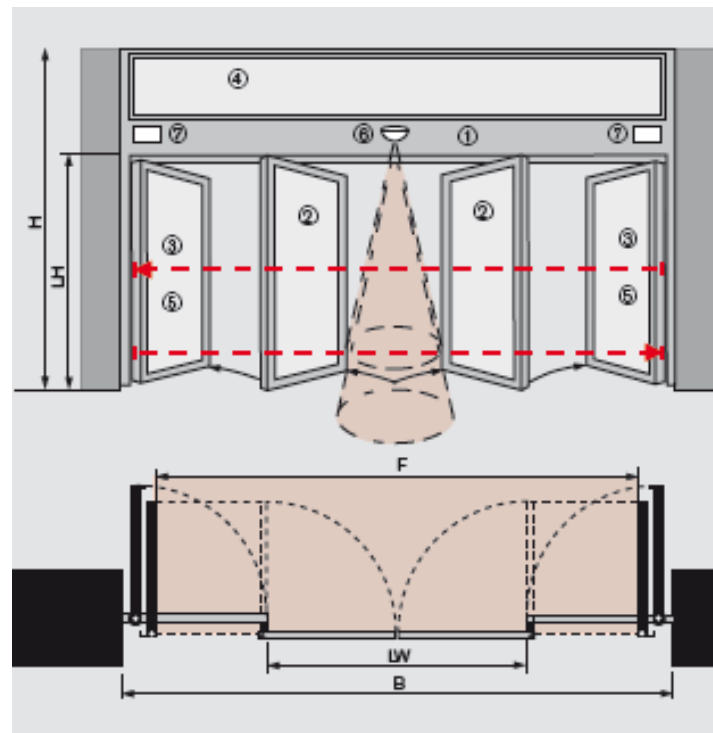

1. Self-supporting transom including operator with integrated control unit
2. Break-out door leaves with toughened or laminated safety glass
3. Break-out side screens
4. Fanlight or cover
5. Safety light barriers
6. Activator, e.g. radar motion detector or Sensors
7. Secondary closing edge protection according to the DIN 18650

LW= Clear opening width
 F = Escape route width
 B = System width
 LH= Clear passage height
 H = System height

Safety Concerns of **SLIDING DOORS**

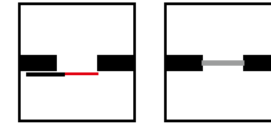

Finger draw in or Finger trap Hazards

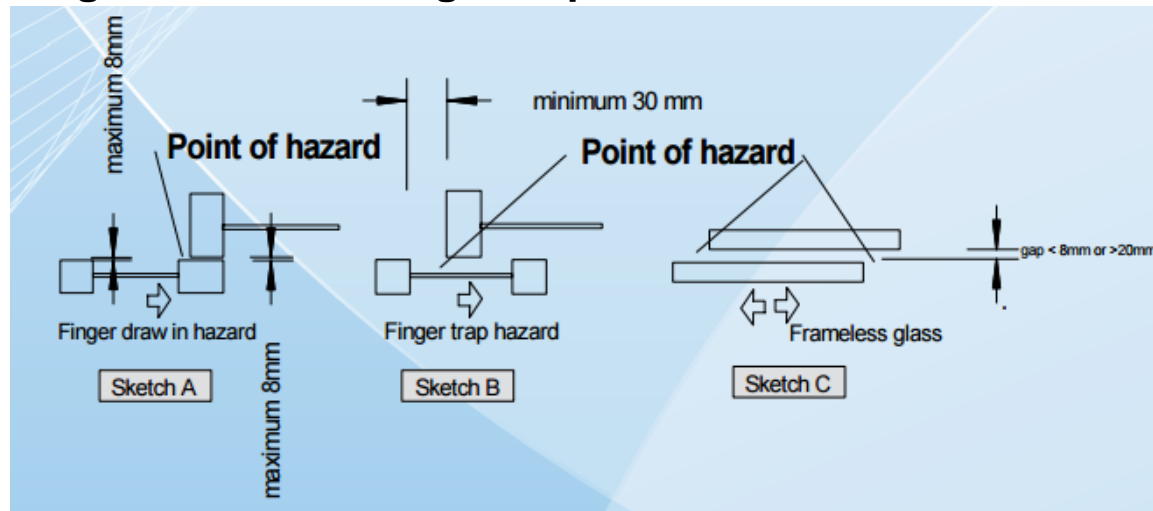

Head & Body Entrapment Hazards

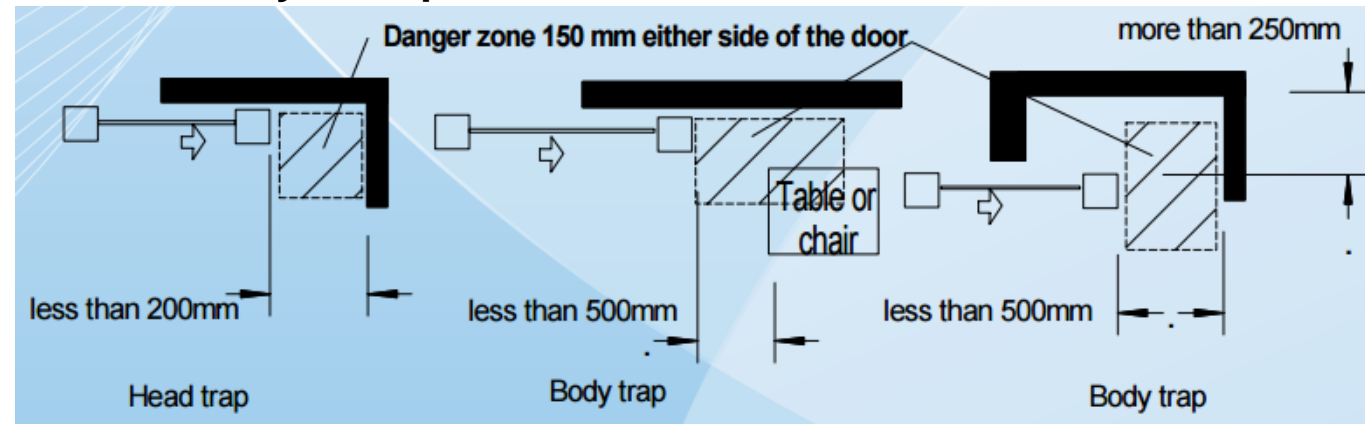



Safety Concerns of **SLIDING DOORS**

Head & Body Entrapment Hazards

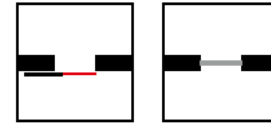



Automatic Doors:

- Standards:

European

- **DIN 18650, BS 7036 and EN16005.** German, BS and EN standards for Automatic Sliding doors,

Australian

- **AS 5007**, Australian standard for Automatic doors

North American

- **ANSI/BHMA A156.10**, Power Operated Pedestrian Doors
- **ANSI/BHMA A156.19**, American National Standard for Power Assist and **Low Energy Power Operated Doors**,



The American Association of Automatic Door Manufacturers (**AAADM**) is a trade association of power-operated automatic door manufacturers. It raise public awareness about automatic doors and administer a program to certify automatic door inspectors.



- Types of mechanism
 - Swing doors
 - Sliding doors
 - **Revolving doors**

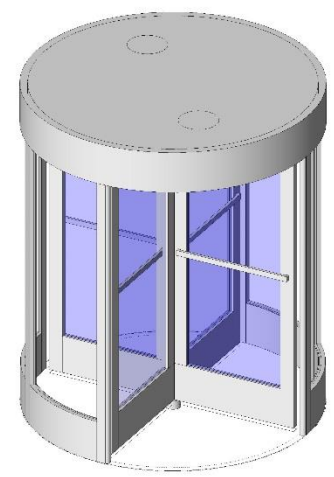
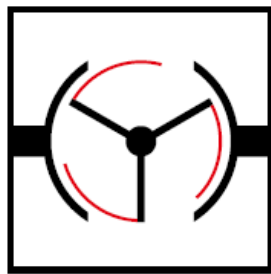

Safety Concerns of **REVOLVING DOORS**

Cocoanut Grove fire



The front of the Cocoanut Grove nightclub after the fire

Time	Around 10:15 P.M.
Date	November 28, 1942
Location	Bay Village, Boston, Massachusetts, United States
Cause	Ignition of synthetic palm tree decorations
Deaths	492

The Cocoanut Grove club was the scene of the deadliest fire in US history, **killing 492 people**

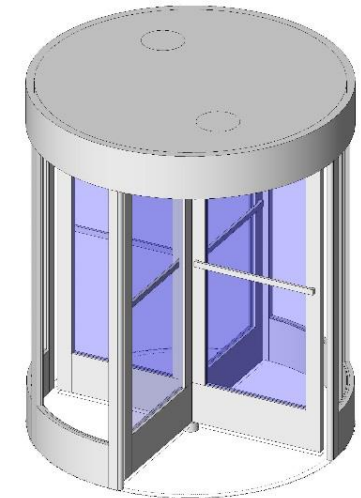
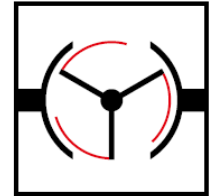

The building's main entrance was a Revolving door.

Bodies piled up behind both sides of the revolving door, jamming it to the extent that firefighters had to dismantle it to enter.

Safety Concerns of REVOLVING DOORS

Cocoanut Grove fire



The front of the Cocoanut Grove nightclub after the fire

Time	Around 10:15 P.M.
Date	November 28, 1942
Location	Bay Village, Boston, Massachusetts, United States
Cause	Ignition of synthetic palm tree decorations
Deaths	492

Revolving doors shall be capable of being collapsed into a book-fold position when a force not exceeding 130 lbf (580 N) is applied to the wings

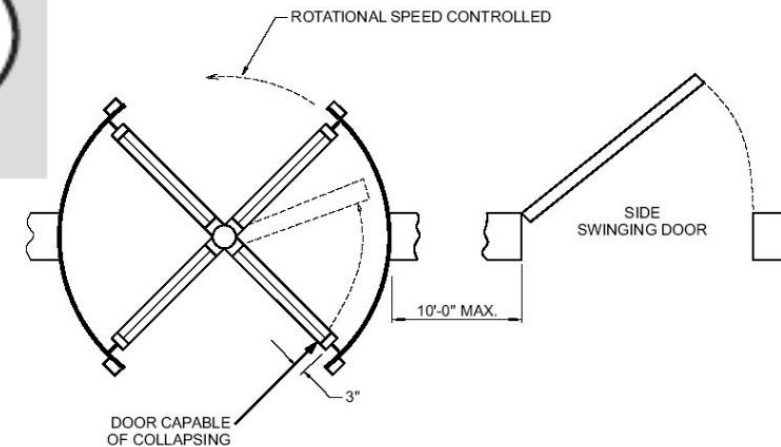
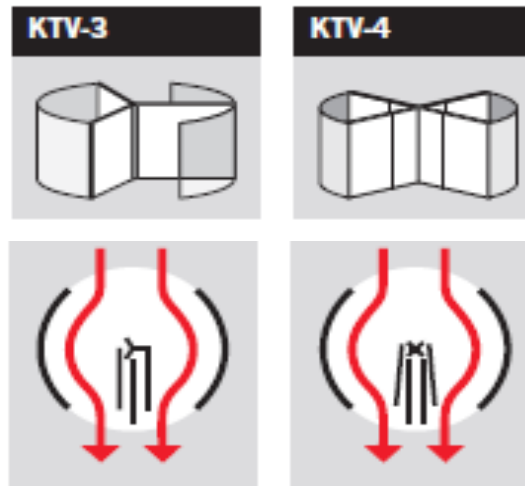
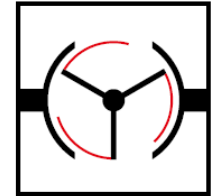

DELAYED EGRESS FUNCTIONS WITH
FRAMELESS GLASS DOORS &
FAIL SECURE FUNCTION

①/②

27.12.2009

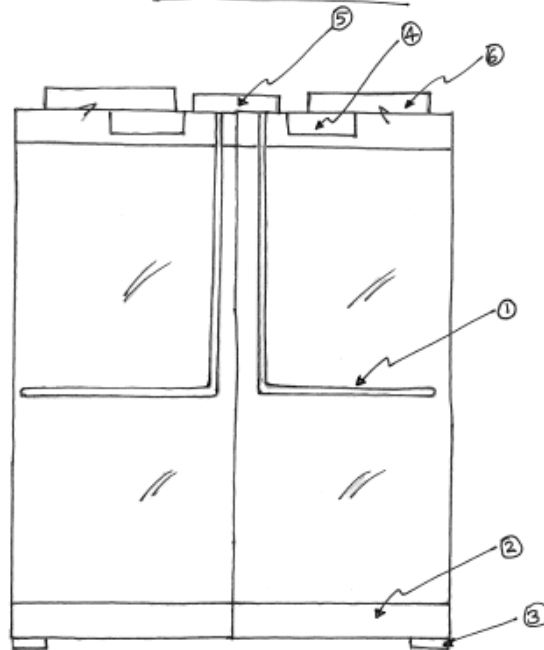

- ① - DG1000 SERIES EXIT DEVICE FOR FRAMELESS DOORS
- ② - TOP & BOTTOM RAILS 100MM, STAINLESS STEEL
- ③ - FLOOR PIVOTS
- ④ - EMDE-1000 DELAYED EGRESS MAG. LOCKS (PUSH SIDE)
- ⑤ - FOLGER ADAMS ELECTRIC STRIKE (BOTH FAIL SAFE &
FAIL SECURE AVAILABLE) - (PULLSIDE)
- ⑥ - ED200 SWING DOOR OPERATOR. (PUSH SIDE OR
PULL SIDE
AVAILABLE)





Arrival

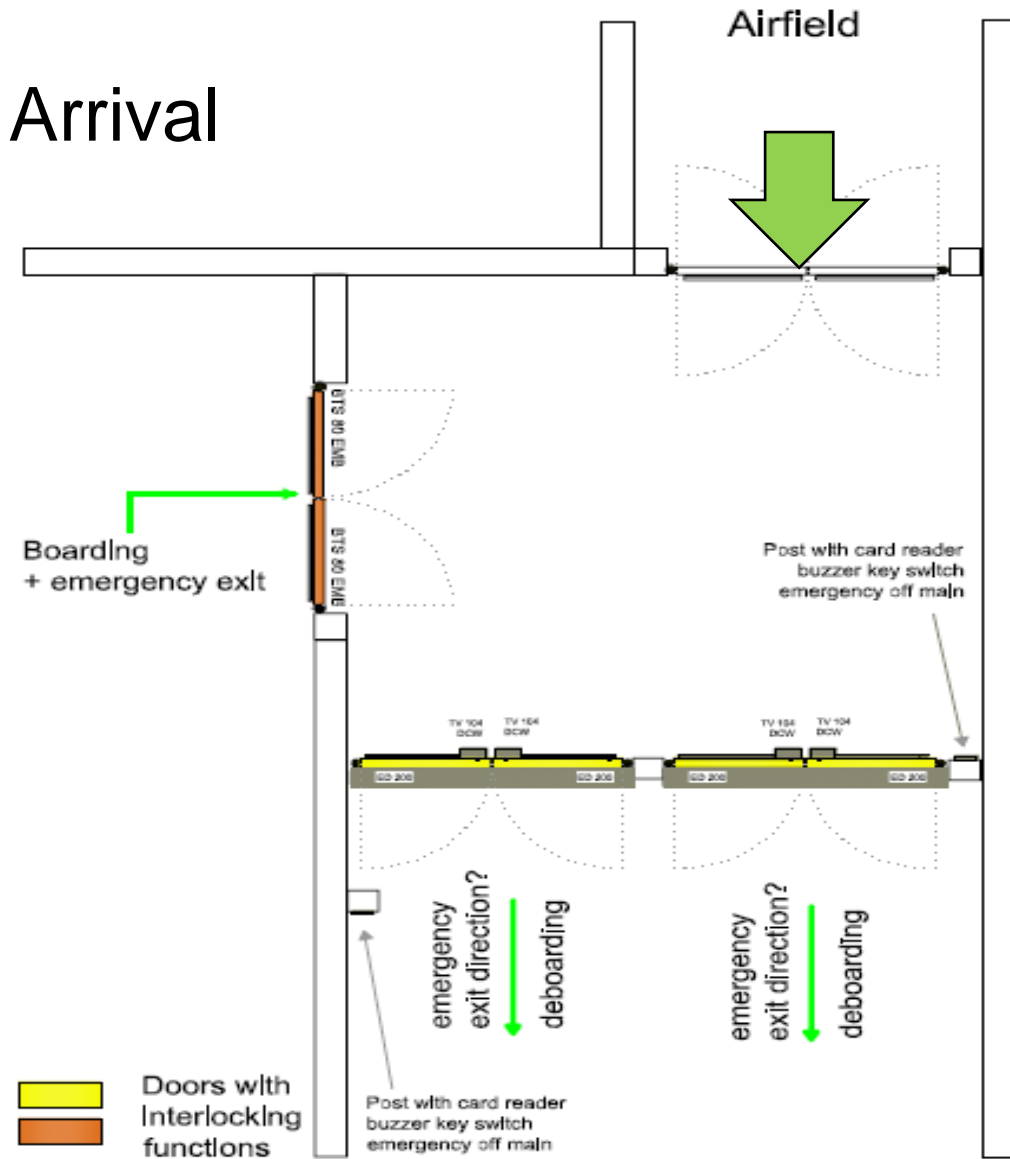



Arrival

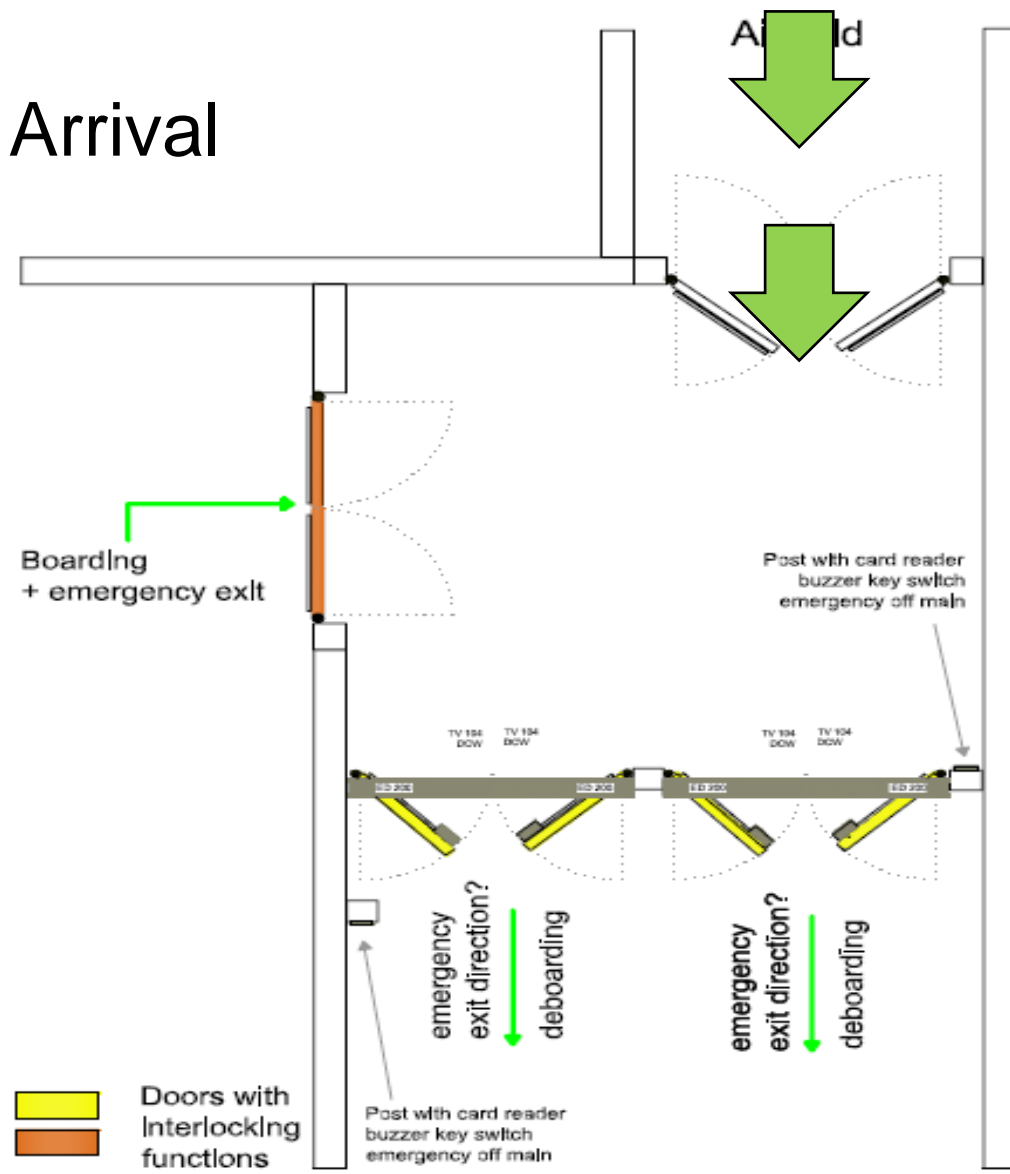



Arrival

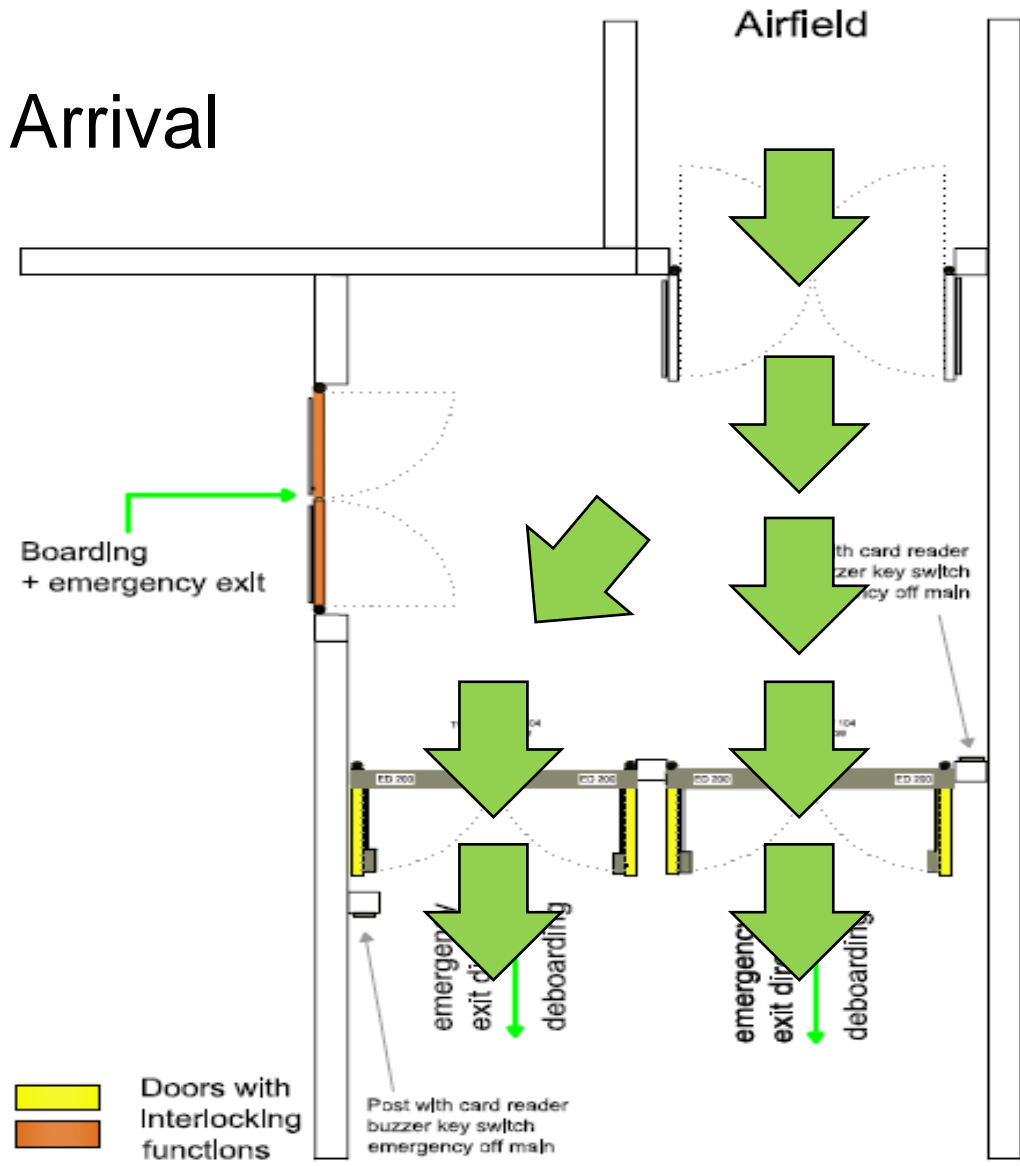



Departure

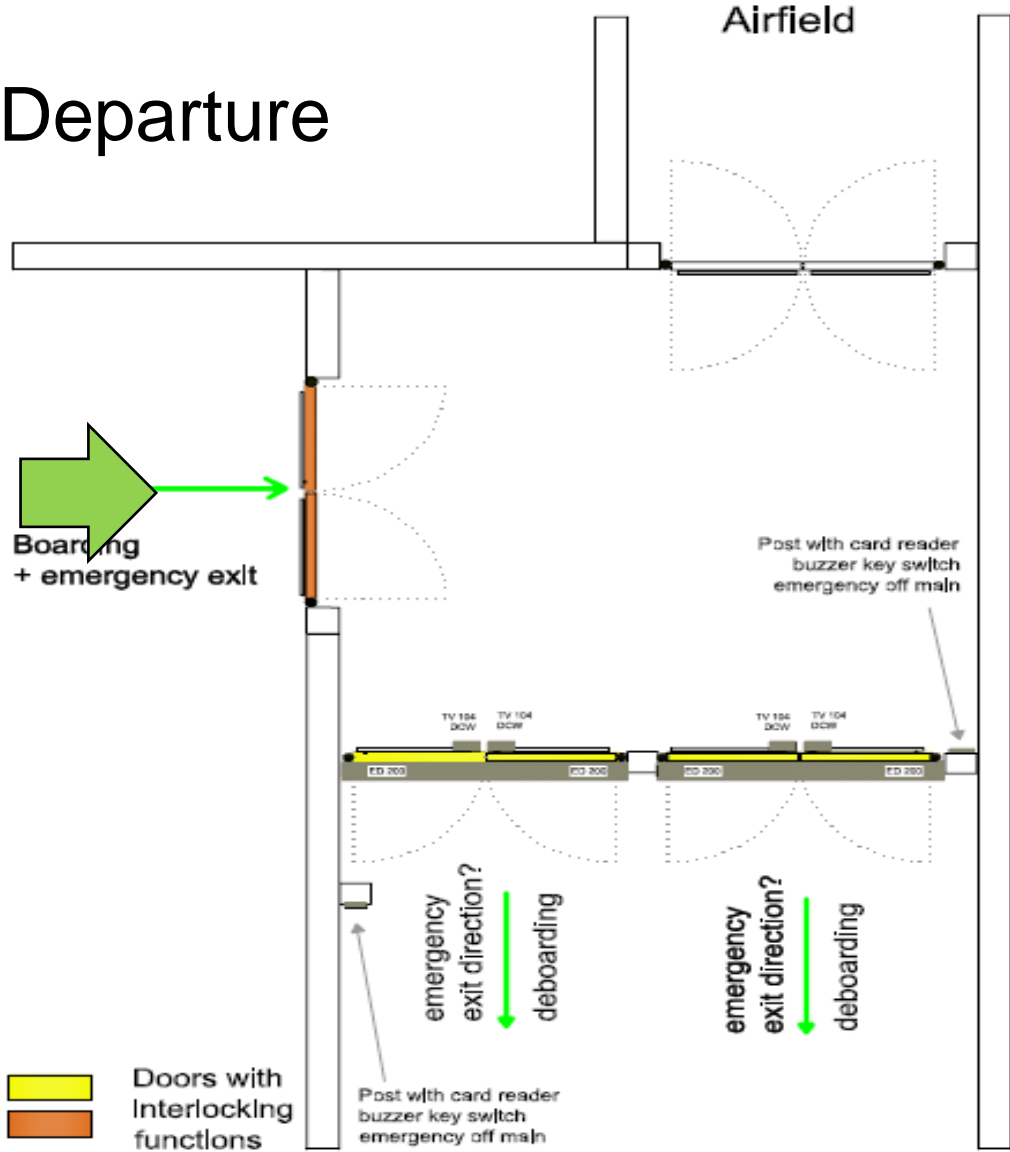



Departure

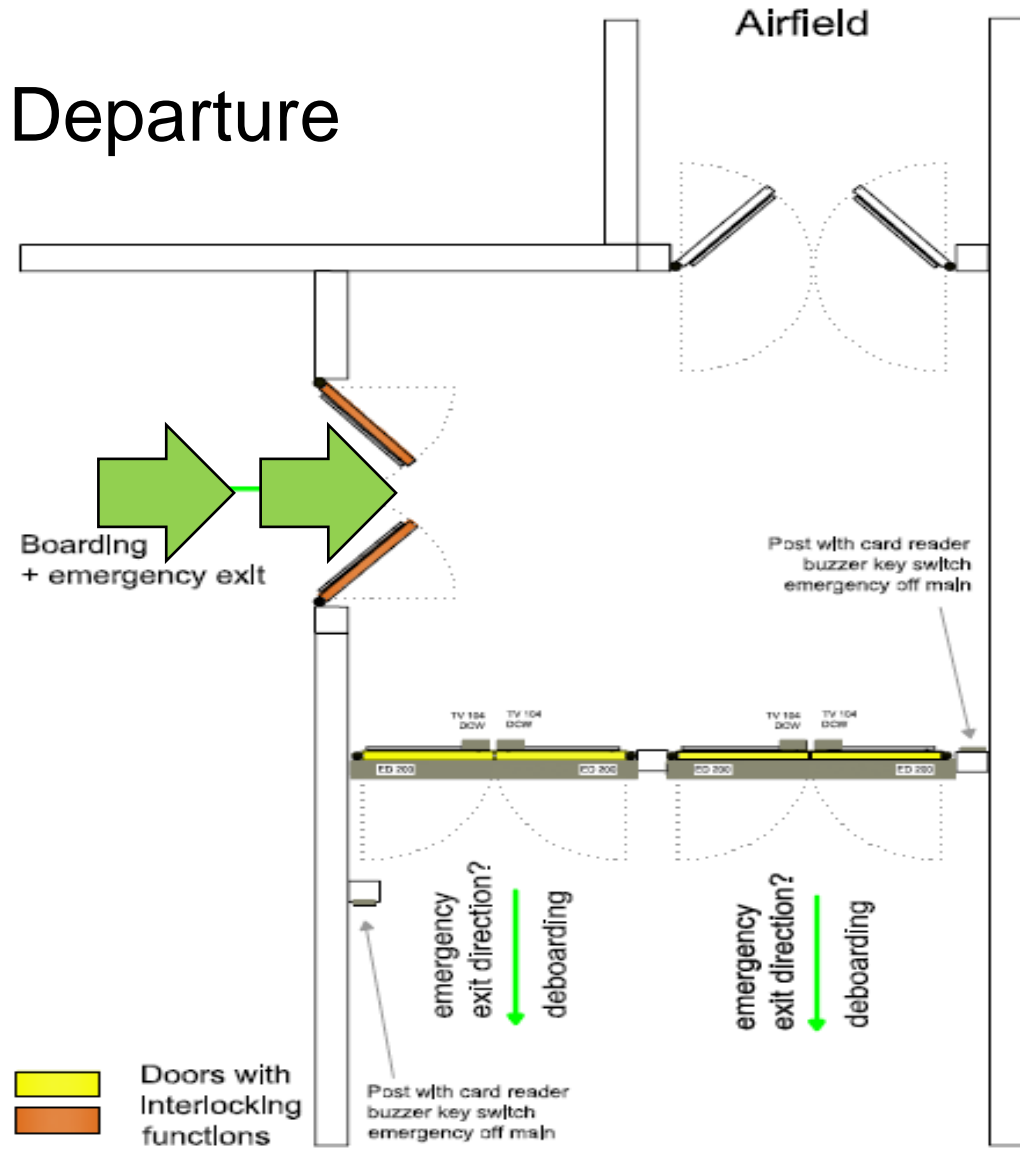



Departure

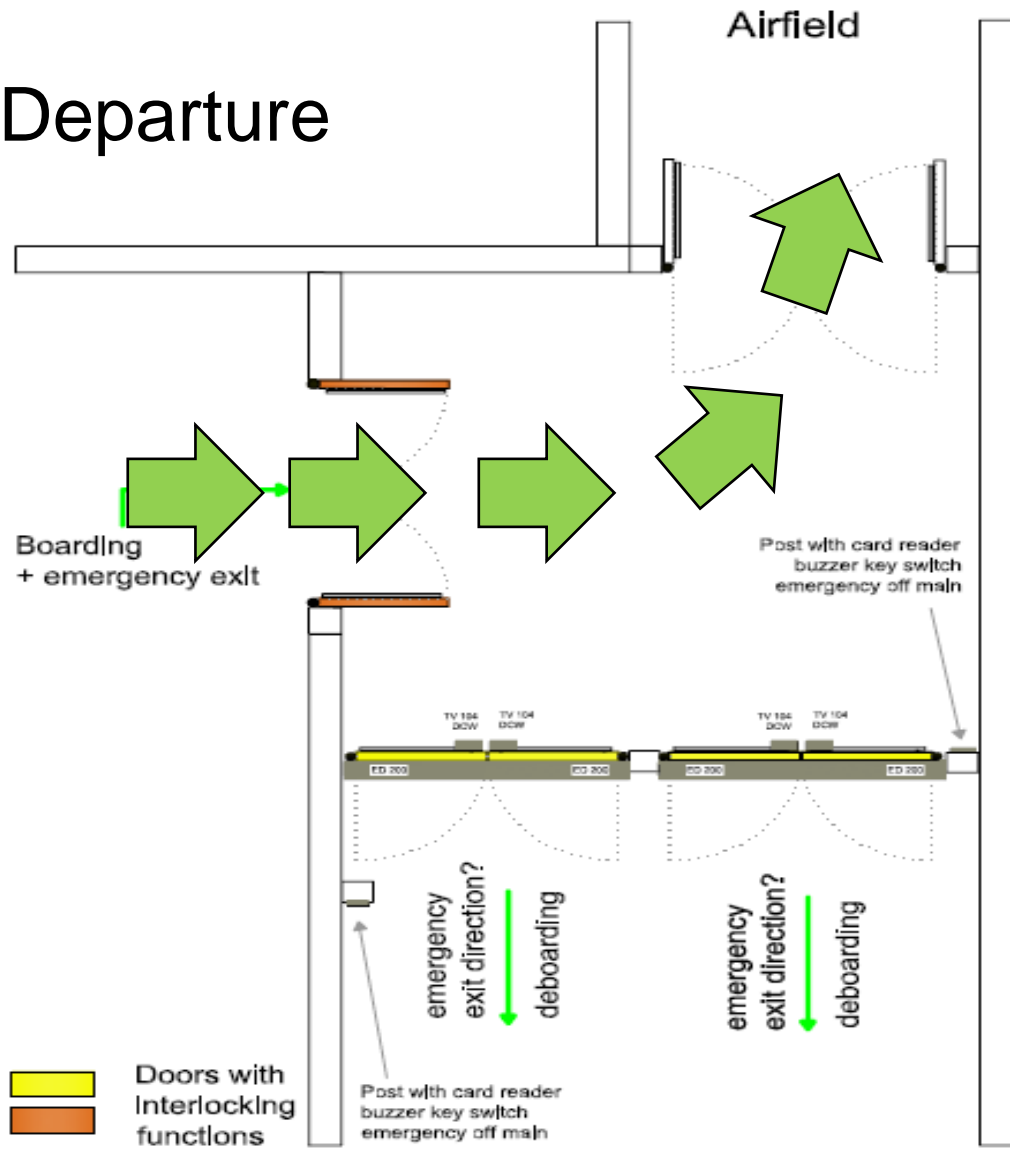



Gold souk at Mall of Dubai

- 750 kg Heavy, Automatic Sliding door
- Dead-man switch





Armani Entrance Swing Door Operators:

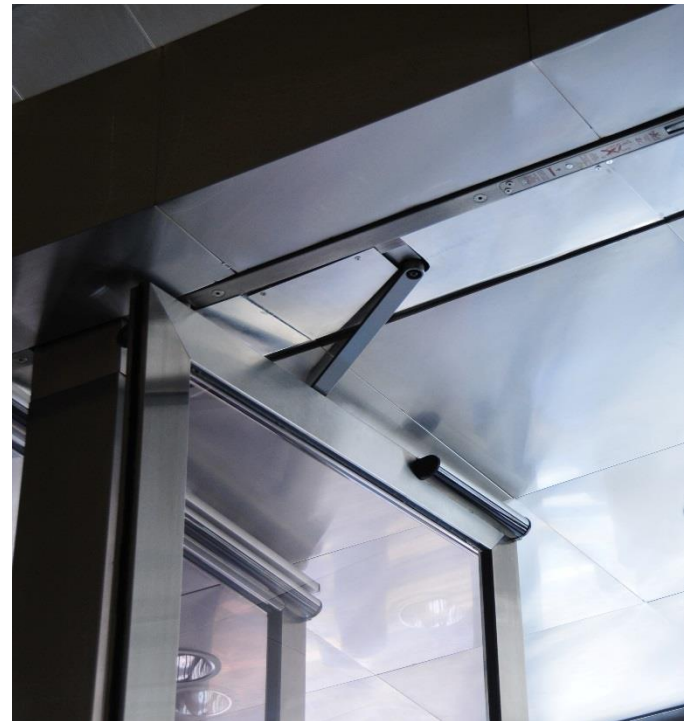

INFRARED-SENSOR

Safety



Reversing



Stop





Smoke Evacuation Corridor Glass Doors :

At every floor, the corridor doors had to be escape doors from the 3 wings of the building to the central lobby, which cannot be locked at any point of time. Additionally, they had to also OPEN to 90 degrees automatically to allow smoke evacuation.

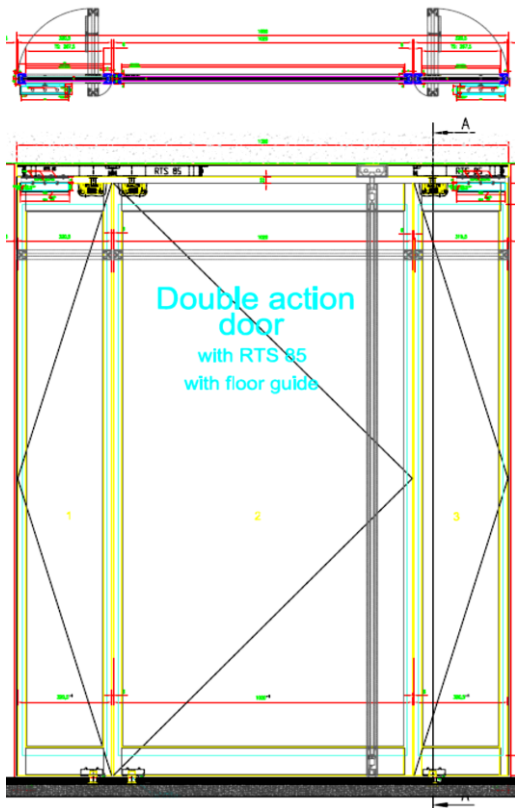



Frameless Glass Exit doors :

Many areas of the lobbies and Armani Prive, demanded elegant frameless glass doors , with no bulky hardware, yet to satisfy codes for escape routes.

We used DORMA DG 1000 series exit devices, with aesthetic stainless steel tubular designs, and floor concealed BTS 80 floor closers, with top and bottom stainless steel rails.

Where access control was needed to allow authorized users in, concealed electric strikes in the header, in tandem with the top latches of the DG 1000 series exit devices, completed the solution.

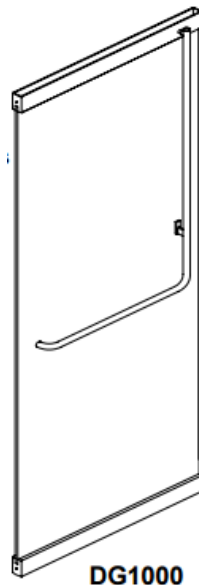

Safety Design in Buildings

Aligning Safety, Security and Aesthetics
in Architectural Openings



Case Study
Burj Khalifa – Guest room doors





Aligning Safety, Security and Aesthetics in Architectural Openings

Altaf A. Afridi

Regional Marketing Director – MENA, DORMA

Email: altaf.afridi@dorma.com

Thank you